

Race time / Lap: \_\_\_\_\_

Best lap: \_\_\_\_\_

Name: \_\_\_\_\_  
 Date: \_\_\_\_\_  
 Track: \_\_\_\_\_

**Diff. Oil**  
 Front: \_\_\_\_\_  
 Center: \_\_\_\_\_  
 Rear: \_\_\_\_\_

**Track Conditions**  
 Size:  Open  Med.  Tight  
 Traction:  High  Med.  Low  
 Surface:  Smooth  Med.  Bumpy

**Tire**  
 Front Type: \_\_\_\_\_  
 Front Foam: \_\_\_\_\_  
 Rear Type: \_\_\_\_\_  
 Rear Foam: \_\_\_\_\_

**Electric System**  
 ESC Type: \_\_\_\_\_  
 Motor Type: \_\_\_\_\_  
 Motor Gear/Spur Gear: \_\_\_\_\_  
 Battery Type A: Standard Pack \_\_\_\_\_  
 Battery Type B: Shorty Pack \_\_\_\_\_

### Front Suspension

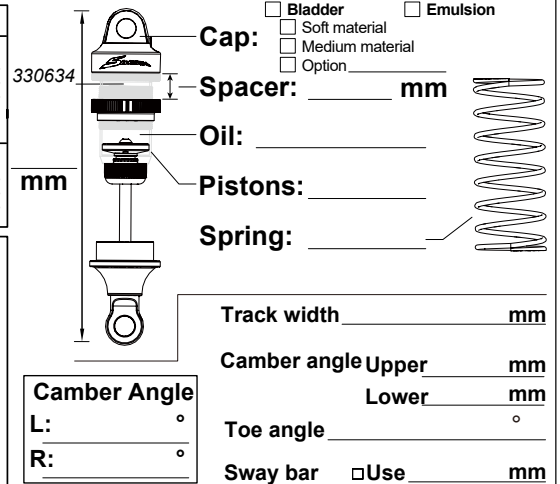
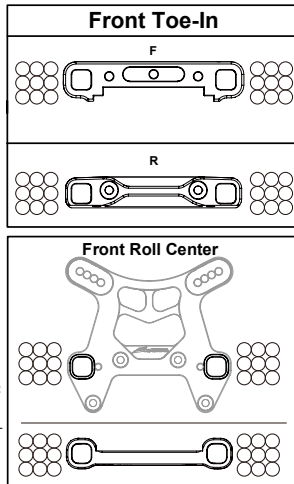
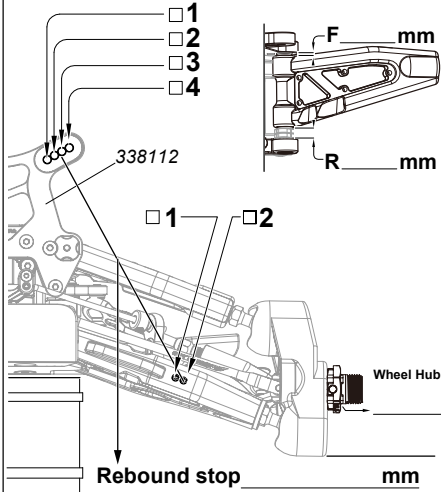

### Rear Suspension

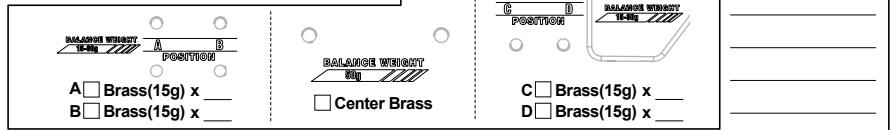
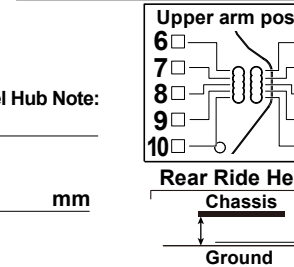
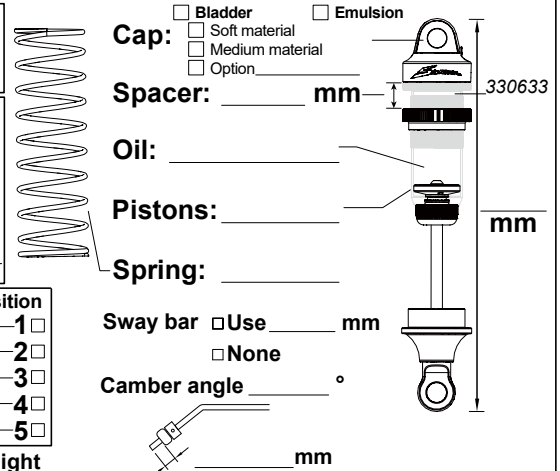
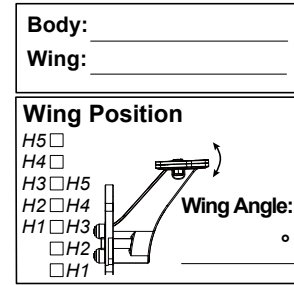
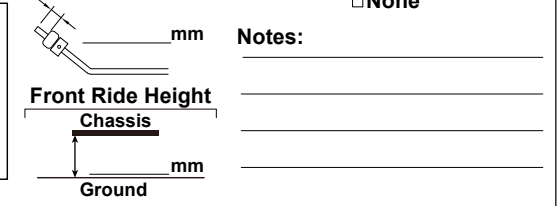
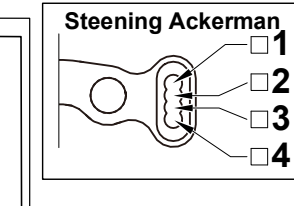
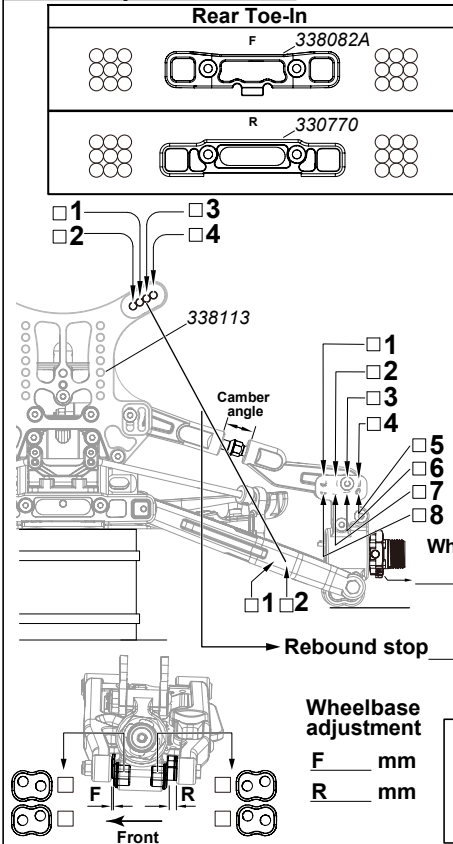

### Option Parts List

**Front Upper Arm**  
 Hard  Soft  
 Carbon Cover \_\_\_\_\_ mm

**Front Lower Arm**  
 Ultra Hard  Hard  Medium  Soft  
 Carbon Cover \_\_\_\_\_ mm

**Rear Lower Arm (228015)**  
 Ultra Hard  Hard  Medium  Soft  
 Use  None  
 Carbon Cover \_\_\_\_\_ mm